

TMR2615x-AAI

Low Power Large Range TMR Linear Magnetic Sensor

Description

The TMR2615x-AAI is a low-power, wide-linear-range, programmable TMR linear sensor IC by MultiDimension Technology. The IC integrates tunnel magnetoresistance (TMR) sensor, programmable operational amplifier, and DAC circuits to provide a linear relationship between analog output voltage and external magnetic field.

The IC can be widely used in various position sensing applications and supports customers' demands for low voltage, high resolution, high signal-to-noise ratio, and wide linear range.

The sensor is either available as TMR2615D-AAI in a DFN3L (2 mm × 2 mm × 0.55 mm) package or as TMR2615F-AAI in DFN3L (1.6 mm × 1.6 mm × 0.5 mm) package. The sensor complies with RoHS standards.

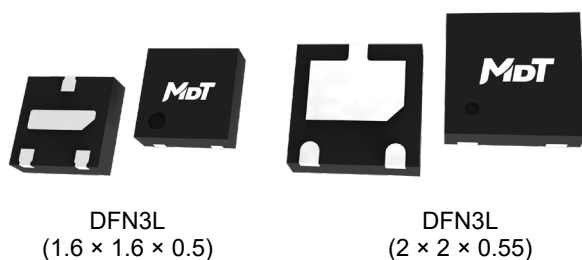

Features and Benefits

- Tunneling magnetoresistance (TMR) technology
- Supply voltage: 1.71 V to 5 V
- Static current consumption < 300 μ A
- Output voltage: 5% to 95% V_{DD}
- Output voltage follows V_{DD} changes
- Low noise
- Sensitivity with high consistency
- Low hysteresis
- RoHS & Reach compliant

Applications

- Angular and linear position sensing
- Speed sensing
- Magnetometer

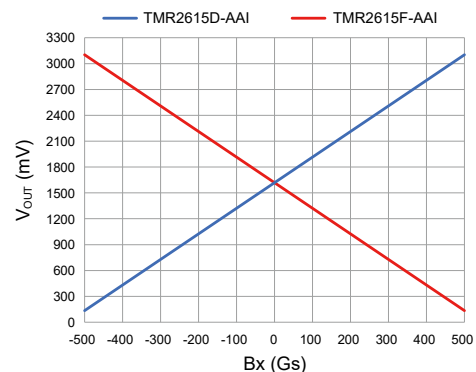

TMR2615x-AAI \pm 500 Gs Output curve

Selection Guide

Part Number*	Supply Voltage	Linear Range	Operating temperature	Static Current Consumption	Package	Packing Form
TMR2615D-AAI-X.XXX-XXX	1.71 V to 5 V	±500 Gs	-40 °C to 125 °C	< 300 μA	DFN3L (2×2×0.55)	Tape & Reel
TMR2615F-AAI-X.XXX-XXX	1.71 V to 5 V	±500 Gs	-40 °C to 125 °C	< 300 μA	DFN3L (1.6×1.6×0.5)	Tape & Reel

Note: Sensitivity and offset voltage can be customized according to customer requirements.

Product Model Description

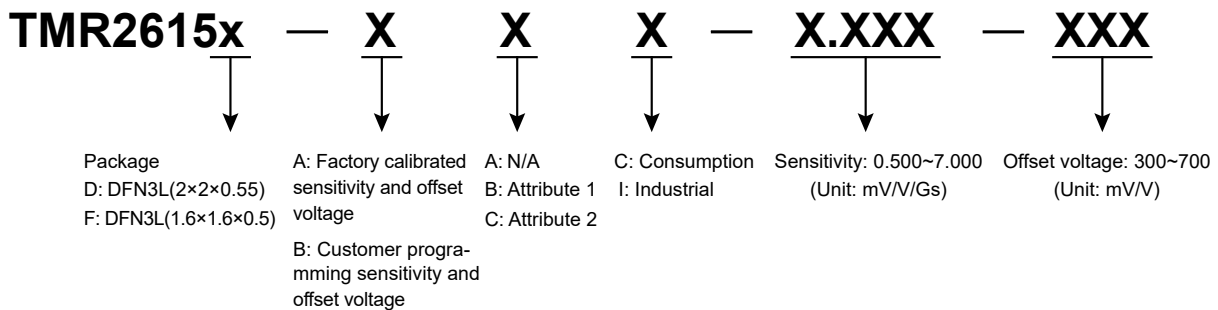

Note: A sensitivity value of 1.000 corresponds to 1.000 mV/V/Gs, please refer to the X axis output curve diagram on the home page. and a zero-offset output voltage value of 500 corresponds to 500 mV/V.

Catalogue

1. Functional Block Diagram.....	03
2. Operating Principle.....	03
3. Pin Configuration.....	03
4. Absolute Maximum Ratings.....	04
5. Electrical Specifications.....	04
6. Output Characteristics.....	05
7. Application Circuit.....	05
8. Dimensions.....	06

1. Functional Block Diagram

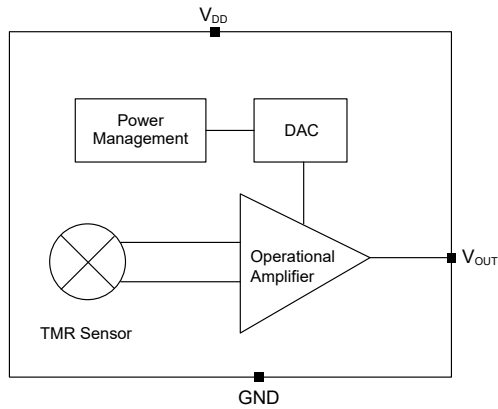

Figure 1. Block Diagram

The TMR2615x-AAI output voltage varies linearly with the magnetic field along the sensing axis.

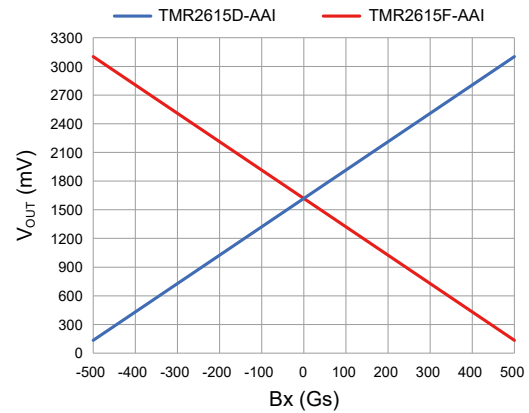

Figure 3. TMR2615x-AAI output curve

2. Operating Principle

The TMR2615x-AAI sensing axis is parallel to the package top-marking surface; the sensing axis is defined from the N pole toward the S pole, as indicated by the arrow in the figure below.

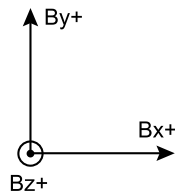

Figure 2-1. Definition of axis

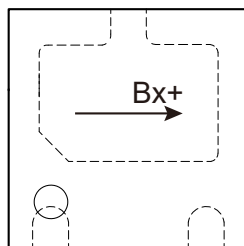

Figure 2-2. Axial diagram (DFN3L(2x2) top view)

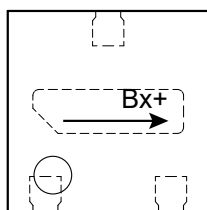
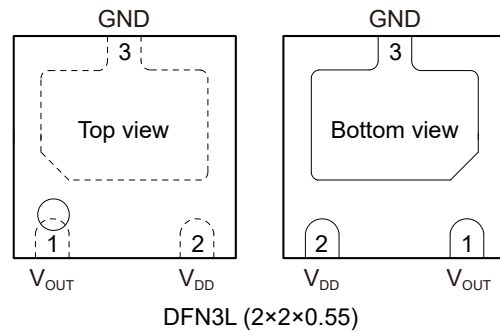
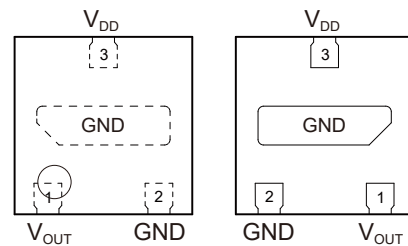

Figure 2-3. Axial diagram (DFN3L(1.6x1.6) top view)

3. Pin Configuration



DFN3L (2x2x0.55)



DFN3L (1.6x1.6x0.5)

Figure 4. Pin Configuration

Pin Number		Name	Function
DFN3L (2x2x0.55)	DFN3L (1.6x1.6x0.5)		
1	1	V _{OUT}	Output voltage
2	3	V _{DD}	Supply voltage
3	2	GND	Ground

4. Absolute Maximum Ratings

Parameters	Symbol	Min.	Max.	Unit
Supply voltage	V_{DD}	-0.3	6	V
External magnetic field	B	-	4000	Gs
V_{OUT} current drive	-	-	1.5	mA
Operating temperature	T_A	-40	125	°C
Storage temperature	T_{STG}	-50	150	°C
ESD (HBM)	V_{ESD}	-	4000	V

Note: The maximum value in the limit parameter only ensures that the IC is not permanently damaged, please refer to the “Electrical Performance Parameters” for normal operating conditions of the IC.

5. Electrical Specifications

$V_{DD} = 1.71\text{ V to }5\text{ V}$, $T_A = 25\text{ °C}$, a 100nF capacitor connected between the power and ground

Parameter	Symbol	Condition	Min.	Typ.	Max.	Unit
Supply voltage	V_{DD}	-	1.71	3.3	5	V
Operating current	I_{CC}	$V_{DD} = 1.8\text{ V}$	-	200	-	μA
		$V_{DD} = 3.3\text{ V}$	-	240	-	μA
Bandwidth	BW	-3 dB	-	-	30	kHz
Load resistance	R_L	-	10	-	-	k Ω
Load conductance	C_L	-	-	-	10	nF
Sensitivity	SEN	Bx: $\pm 500\text{Gs}$	User programmable			mV/V/Gs
Temperature coefficient of sensitivity	TCS	$T_A = -40\text{ °C to }125\text{ °C}$	-	1000	-	PPM/°C
Offset voltage	V_{OFFSET}	-	User programmable			mV/V
Temperature coefficient of offset	TCO	$T_A = -40\text{ °C to }125\text{ °C}$	-	-0.12	-	mV/°C
Nonlinearity	NONL	Bx: $\pm 500\text{Gs}$	-	2	-	%FS
Hysteresis	HYS	Bx: $\pm 500\text{Gs}$	-	2	-	%FS
Noise	V_N	$V_{DD} = 3.3\text{ V}$, BW = 5 kHz	-	-	10	mV _{pp}
Power-on time	t_{PO}	-	-	-	100	μs

6. Output Characteristics

As shown in Figure 5, the output voltage of the TMR2615x-AAI IC changes with the external magnetic field intensity. When there is no magnetic field, V_{OUT} outputs $50\% V_{DD}$, and when the magnetic field changes from $-B$ to B , the linear output voltage range of V_{OUT} for TMR2615D-AAI is $5\% V_{DD}$ to $95\% V_{DD}$, the linear output voltage range of V_{OUT} for TMR2615F-AAI is $95\% V_{DD}$ to $5\% V_{DD}$. Customers can modify the linear range through the adjustment provided by the TMR2615x-AAI.

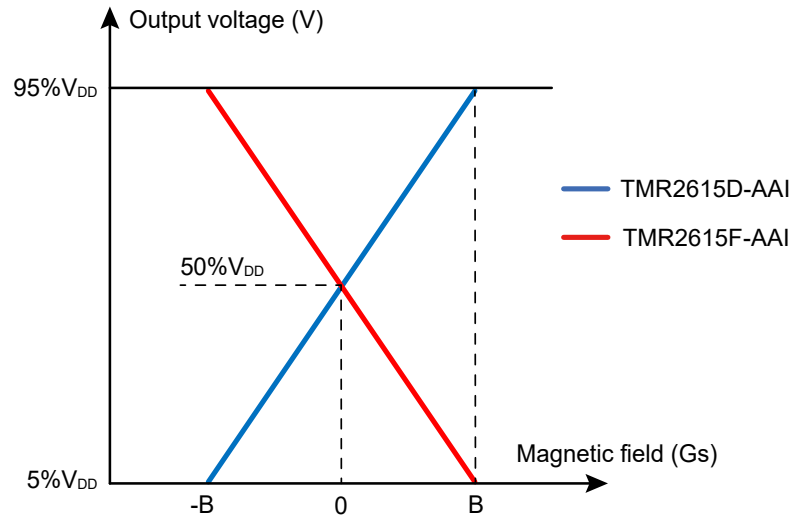

Figure 5. Output voltage versus magnetic field

7. Application Circuit

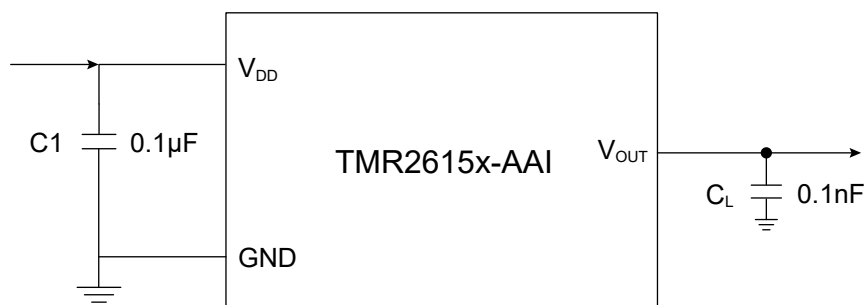

Figure 6. Application circuit diagram

Note: C1 should be as close as possible to the V_{DD} and GND pins. For detailed pin definitions, please refer to section 3 Pin Configuration.

8. Dimensions

DFN3L (2×2×0.55) Package

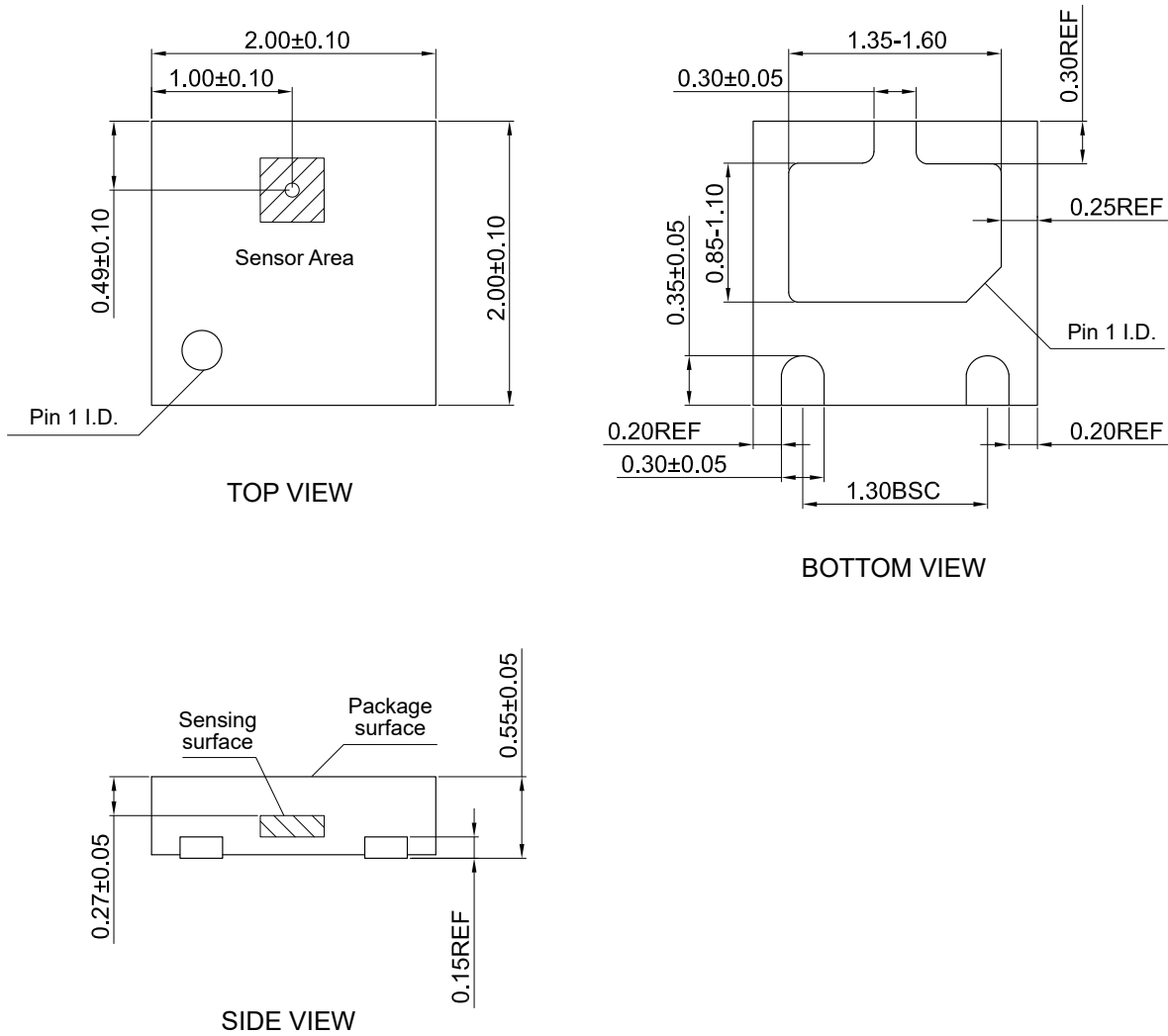

Figure 7. Package outline of DFN3L (2×2×0.55) (unit: mm)

DFN3L (1.6×1.6×0.5) Package

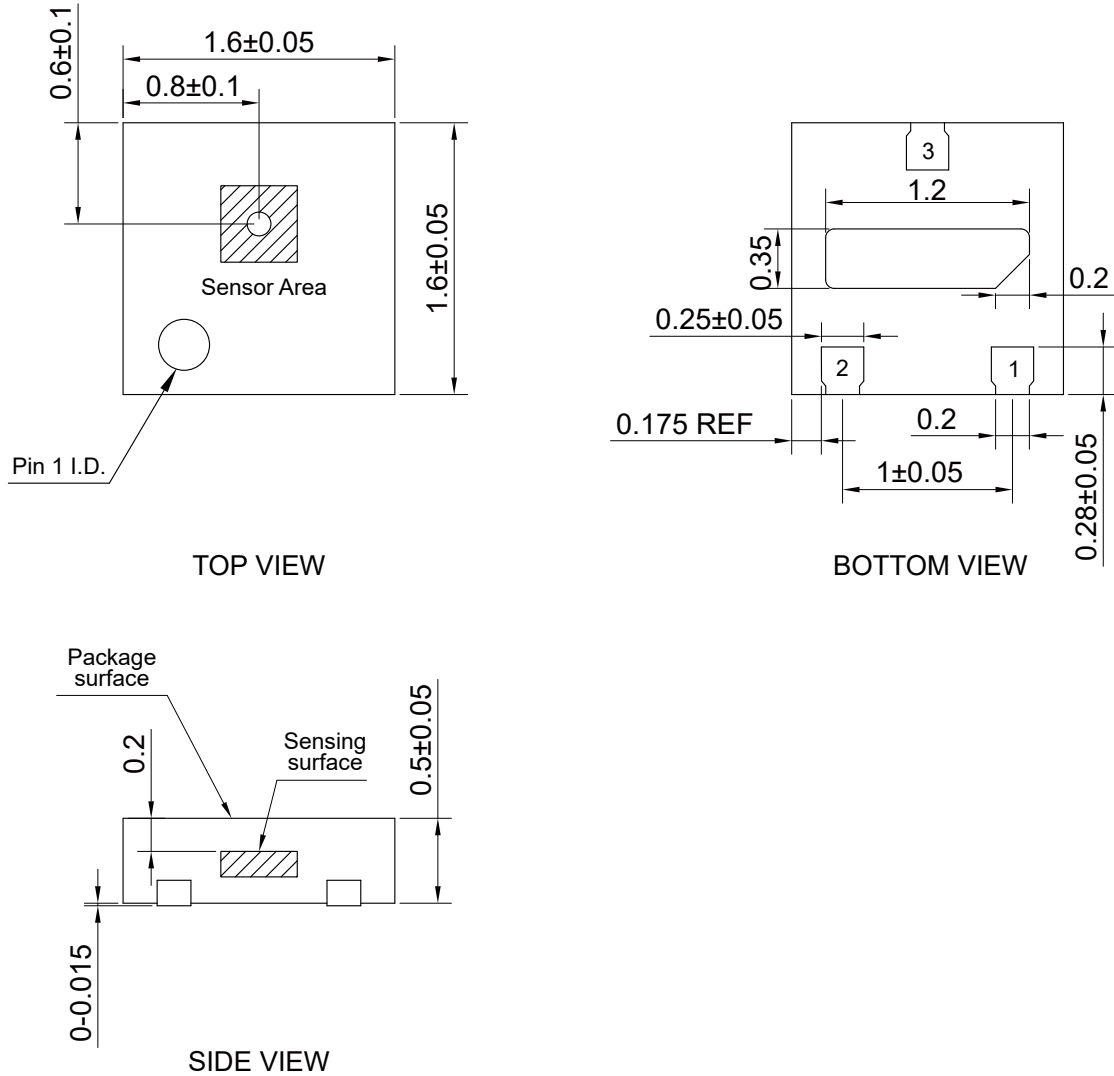

Figure 8. Package outline of DFN3L (1.6×1.6×0.5) (unit: mm)

Copyright © 2026 by MultiDimension Technology Co., Ltd.

Information furnished herein by MultiDimension Technology Co., Ltd. (hereinafter MDT) is believed to be accurate and reliable. However, MDT disclaims any and all warranties and liabilities of any kind, with respect to any examples, hints or any performance or use of technical data as described herein and/or any information regarding the application of the product, including without limitation warranties of non-infringement of intellectual property rights of any third party. This document neither conveys nor implies any license under patent or other industrial or intellectual property rights. Customer or any third-party must further determine the suitability of the MDT products for its applications to avoid the applications default of customer or third-party. MDT accept no liability in this respect.

MDT does not assume any liabilities of any indirect, incidental, punitive, special or consequential damages (including without limitation of lost profits, lost savings, business interruption, costs related to the removal or replacement of any products or rework charges) whether or not such damages are based on tort (including negligence), warranty, breach of contract or any other legal theory. Notwithstanding any damages that customer might incur for any reason whatsoever, MDT's aggregate and cumulative liability towards customer for the products described herein shall be limited in accordance with the terms and conditions of commercial sale of MDT.

Absolute maximum ratings are the extreme limits the device will withstand without damage to the MDT product. However, the electrical and mechanical characteristics are not guaranteed as the maximum limits (above recommended operating conditions) are approached. MDT disclaims any and all warranties and liabilities of the MDT product will operate at absolute maximum ratings.

Specifications may change without notice.

Please download latest document from our official website www.dowaytech.com/en.

Recycling

The product(s) in this document need to be handed over to a qualified solid waste management services company for recycling in accordance with relevant regulations on waste classification after the end of the product(s) life.



No.2 Guangdong Road, Zhangjiagang Free Trade Zone, Jiangsu, China

Web: www.dowaytech.com/en E-mail: info@dowaytech.com

