

TMR3081

High Performance Automotive TMR Angle Sensor

Description

The TMR3081 high-precision magnetic angle sensor adopts two orthogonal push-pull Wheatstone bridge design, and each bridge contains four high-sensitivity TMR sensing elements. Such design effectively compensates thermal drift ensuring high performance in harsh conditions.

The voltage signals generated by the two sensor axes exhibit a sinusoidal relationship with the angle of the magnetic field in general angle sensor applications, when a magnet is positioned above the TMR3081 to provide a magnetic field parallel to sensor surface.

The TMR3081 achieves low angle error under 0.8 degree for applied magnetic field between 200 Gs and 800 Gs. The TMR3081 is available in TSSOP8 with P/N TMR3081TP.



TSSOP8



Features and Benefits

- Tunneling magnetoresistance (TMR) technology
- SIN/COS differential analog output
- Wide range supply voltage
- Excellent temperature stability
- Excellent resistance to external magnetic field interference
- Two bridges in one package
- Compliant with the AEC-Q100 standard for automotive
- RoHS and REACH compliant

Applications

- Absolute angle sensor
- Electric power steering motor shaft angle sensor
- Steering wheel angle sensor
- Pedal position sensor
- Throttle position sensor

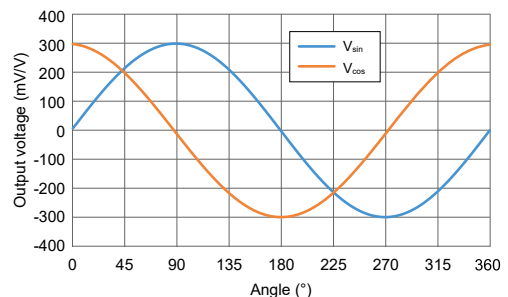

TMR3081 Output curve

Selection Guide

Part Number	Output	Supply Voltage	Peak Voltage Output	Package	Packing Form
TMR3081TP	Differential analog	1.0 V to 5.5 V	600 mV/V	TSSOP8	Tape & Reel

Catalogue

1. Functional Block Diagram.....	03
2. Pin Configuration.....	03
3. Operating Principle.....	04
4. Absolute Maximum Ratings.....	05
5. Electrical Specifications.....	05
6. Specification Definitions.....	06
7. Dimensions.....	07

1. Functional Block Diagram

The TMR3081 consist of TMR (Tunnel Magnetoresistance) Wheatstone bridge structures, which enhance the sensor's output signal amplitude, improve the temperature characteristics of the sensor, and enhance the sensors' anti-interference performance. The functional block diagram of the TMR3081 is shown in Figure 1.

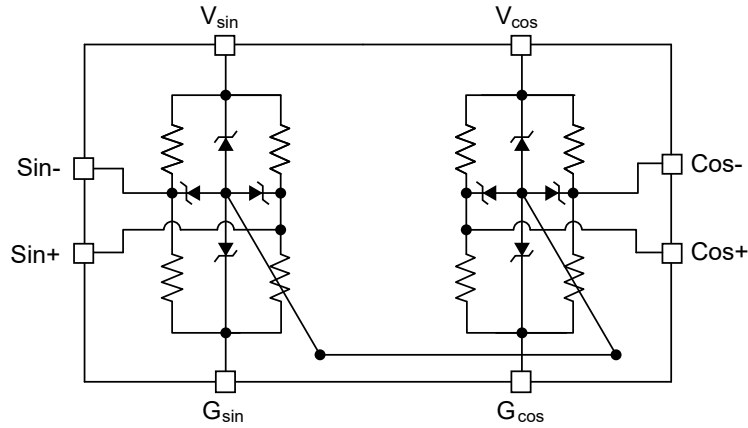

Figure 1. Block diagram

2. Pin Configuration

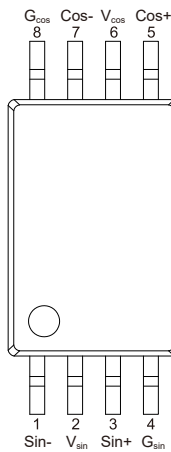

Figure 2. Pin configuration (TSSOP8)

Number	Name	Function
1	Sin-	Reverse sin signal output
2	V _{sin}	Sin bridge supply voltage
3	Sin+	Forward sin signal output
4	G _{sin}	Sin bridge ground
5	Cos+	Forward cos signal output
6	V _{cos}	Cos bridge supply voltage
7	Cos-	Reverse cos signal output
8	G _{cos}	Cos bridge ground

3. Operating Principle

The sensing direction is parallel to the sensor surface as shown in Figure 3.

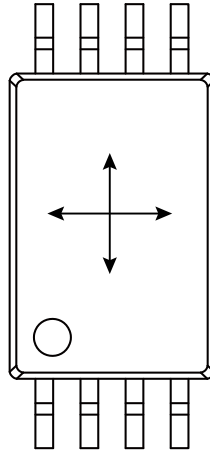

Figure 3. Sensing direction (TSSOP8)

By rotating a small magnet placed on top of TMR3081, a rotating magnetic field parallel to the surface of the magnetic is generated and is at the same angle as the magnet. Figure 4 shows the typical output signals of the TMR3081 in response to a rotating field.

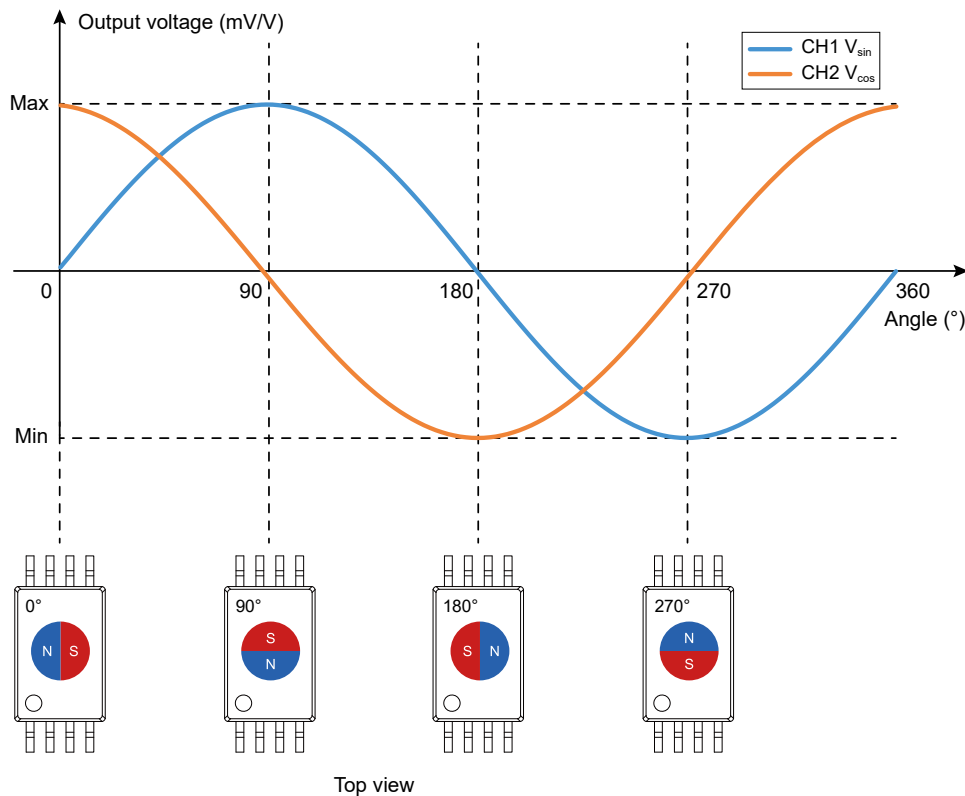

Figure 4. Typical TMR3081 output curve in response to magnet

4. Absolute Maximum Ratings

Parameters	Symbol	Min.	Max.	Unit
Supply voltage	V_{CC}	-	6.5	V
Magnetic flux density	B	-	4000	Gs
ESD performance (HBM)	$V_{ESD(HBM)}$	-	4000	V
ESD performance (CDM)	$V_{ESD(CDM)}$	-	750	V
Operating ambient temperature	T_A	-40	150	°C
Storage ambient temperature	T_{STG}	-55	150	°C
Reflow temperature	T_{reflow}	-	260	°C

Note: The absolute maximum rating only lists the conditions under which the sensors are not permanently damaged. For normal operations please refer to Specifications.

5. Electrical Specifications

$T_A = 25\text{ °C}$, $B = 200\text{ Gs}$, $V_{CC} = 5\text{ V}$, a $0.1\text{ }\mu\text{F}$ capacitor is connected between V_{CC} and GND unless specified otherwise

Parameter	Symbol	Condition	Min.	Typ.	Max.	Unit
Supply voltage	V_{CC}	operating	1	5	5.5	V
Bridge resistance	R_B	$T_A = 25\text{ °C}$, $B = 200\text{ Gs}$	3	5	7	k Ω
Peak voltage	V_{PEAK}	$T_A = 25\text{ °C}$, $B = 200\text{ Gs}$	270	300	335	mV/V
Peak peak voltage	V_{PP}	$T_A = 25\text{ °C}$, $B = 200\text{ Gs}$	540	600	670	mV/V
Offset voltage	V_{OFFSET}	$T_A = 25\text{ °C}$, $B = 200\text{ Gs}$	-5	-	5	mV/V
Angular error ¹⁾	$\Delta\theta$	$T_A = -40\text{ °C}$ to 150 °C , $B = 200\text{ Gs}$ to 800 Gs	-	-	0.8	deg
Phase error	-	$T_A = 25\text{ °C}$, $B = 200\text{ Gs}$ to 800 Gs	87	90	93	deg
Hysteresis	Hyst	$T_A = 25\text{ °C}$, $B > 200\text{ Gs}$	-	0	-	Gs
Peak synchronization coefficient	k	$T_A = 25\text{ °C}$, $B = 200\text{ Gs}$	95	100	105	%
Operation coefficient of peak voltage	TCV_{PEAK}	$T_A = -40\text{ °C}$ to 150 °C , $B = 200\text{ Gs}$ to 800 Gs	-0.2	-0.15	-0.075	%/°C
Operation coefficient of bridge resistance	TCR_B	$T_A = -40\text{ °C}$ to 150 °C , $B = 200\text{ Gs}$ to 800 Gs	-0.07	-0.05	-0.03	%/°C
Peak synchronization temperature coefficient	TCk	$T_A = -40\text{ °C}$ to 150 °C , $B = 200\text{ Gs}$ to 800 Gs	-0.02	-	0.02	%/°C
Operation coefficient of offset voltage	TV_{OFFSET}	$T_A = -40\text{ °C}$ to 150 °C , $B = 200\text{ Gs}$ to 800 Gs	-1.5	-	1.5	mV/V

Notes:

1) Angle error is defined by zero-to-peak.

6. Specification Definitions

6.1 Bridge resistance R_B

The resistance between pins V_{\sin} and G_{\sin} or the resistance between pins V_{\cos} and G_{\cos}

6.2 Peak voltage V_{PEAK} , Peak peak voltage V_{PP}

$$V_{PP} = V_{Max} - V_{Min}$$

$$V_{PEAK} = \frac{V_{Max} - V_{Min}}{2}$$

6.3 Offset voltage V_{OFFSET}

$$V_{OFFSET} = \frac{V_{Max} + V_{Min}}{2}$$

6.4 Peak synchronization coefficient k

$$k = \frac{V_{COS (PEAK)}}{V_{SIN (PEAK)}}$$

6.5 Operation coefficient of peak voltage TCV_{PEAK}

$$TCV_{PEAK} = \frac{V_{PEAK}(T2) - V_{PEAK}(T1)}{V_{PEAK}(25^{\circ}C) \times (T2-T1)} \times 100\%$$

$$T1 = T_A (Min) = -40^{\circ}C, T2 = T_A (Max) = 150^{\circ}C$$

6.6 Peak synchronization temperature coefficient TCR_B

$$TCR_B = \frac{R_B(T2) - R_B(T1)}{R_B(25^{\circ}C) \times (T2-T1)} \times 100\%$$

$$T1 = T_A (Min) = -40^{\circ}C, T2 = T_A (Max) = 150^{\circ}C$$

6.7 Peak synchronization temperature coefficient TCk

$$TCk = \frac{k(T2) - k(T1)}{(T2-T1)} \times 100\%$$

$$T1 = T_A (Min) = -40^{\circ}C, T2 = T_A (Max) = 150^{\circ}C$$

6.8 Operation coefficient of offset voltage TV_{OFFSET}

$$TV_{OFFSET} = V_{OFFSET}(T2) - V_{OFFSET}(T1)$$

$$T1 = T_A (Min) = -40^{\circ}C, T2 = T_A (Max) = 150^{\circ}C$$

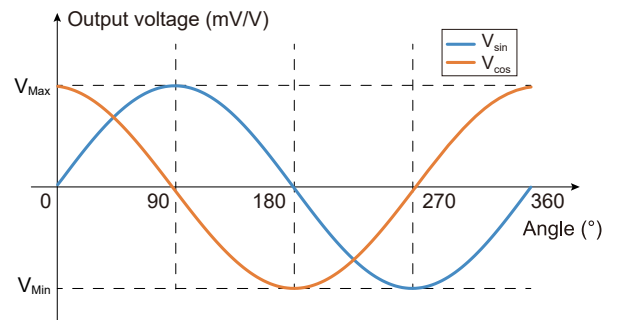

Figure 5. Output curve

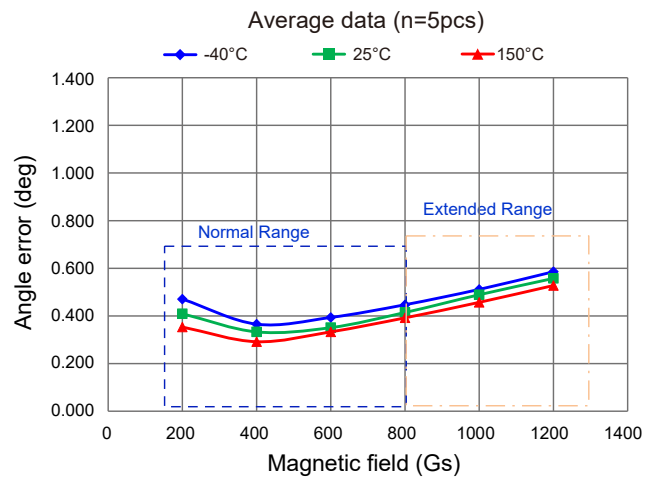

Figure 6. Magnetic field diagram

7. Dimensions

TSSOP8 Package

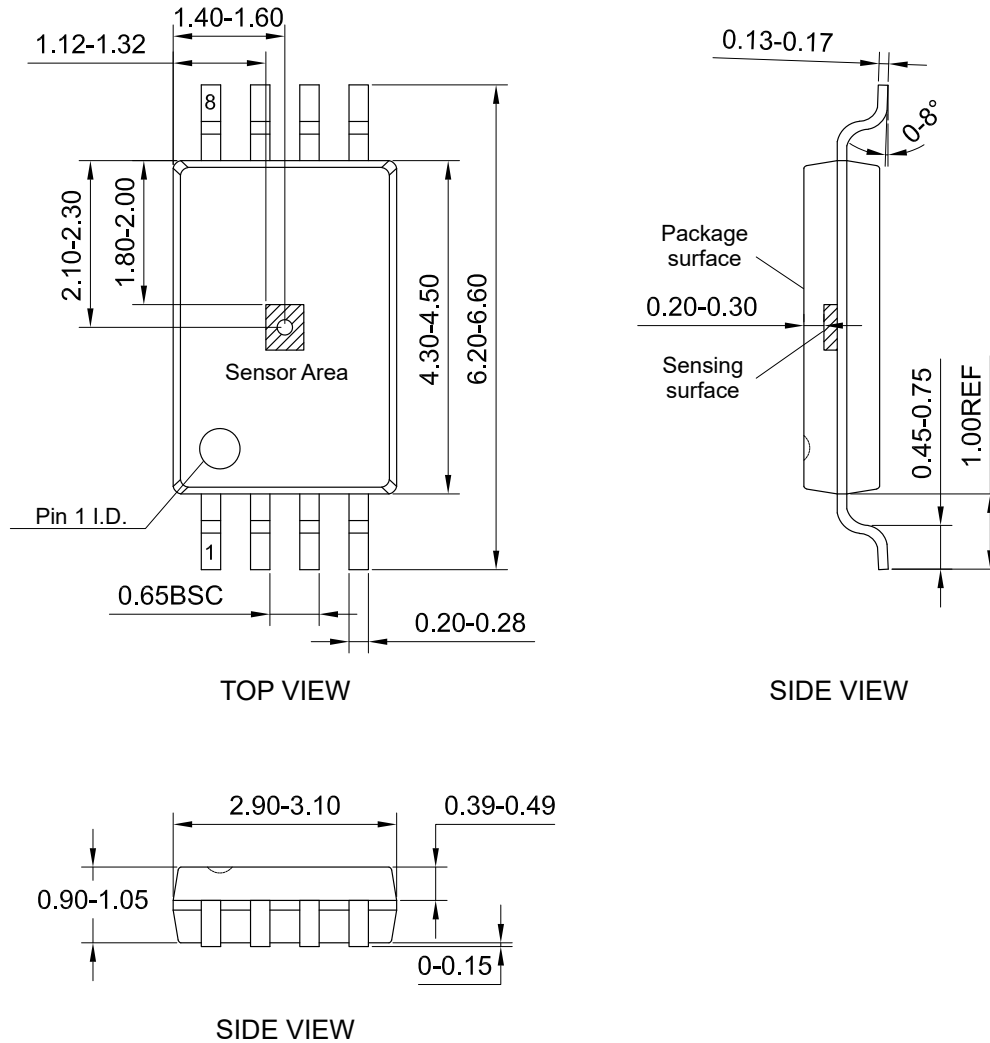

Figure 7. Package outline of TSSOP8 (unit: mm)

Product Marking Description

“XXXX” represents the part number. “Y” represents the year of material input.

“W” represents the week of material input.

“L” represents the batch of material input, with one character for each wafer per input;

“AAAAAA” represents the serial number. Each product has a unique number, ranging from 000001 to 999999.

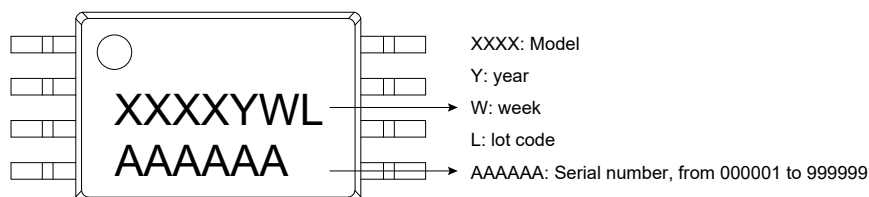

Copyright © 2025 by MultiDimension Technology Co., Ltd.

Information furnished herein by MultiDimension Technology Co., Ltd. (hereinafter MDT) is believed to be accurate and reliable. However, MDT disclaims any and all warranties and liabilities of any kind, with respect to any examples, hints or any performance or use of technical data as described herein and/or any information regarding the application of the product, including without limitation warranties of non-infringement of intellectual property rights of any third party. This document neither conveys nor implies any license under patent or other industrial or intellectual property rights. Customer or any third-party must further determine the suitability of the MDT products for its applications to avoid the applications default of customer or third-party. MDT accept no liability in this respect.

MDT does not assume any liabilities of any indirect, incidental, punitive, special or consequential damages (including without limitation of lost profits, lost savings, business interruption, costs related to the removal or replacement of any products or rework charges) whether or not such damages are based on tort (including negligence), warranty, breach of contract or any other legal theory. Notwithstanding any damages that customer might incur for any reason whatsoever, MDT's aggregate and cumulative liability towards customer for the products described herein shall be limited in accordance with the terms and conditions of commercial sale of MDT.

Absolute maximum ratings are the extreme limits the device will withstand without damage to the MDT product. However, the electrical and mechanical characteristics are not guaranteed as the maximum limits (above recommended operating conditions) are approached. MDT disclaims any and all warranties and liabilities of the MDT product will operate at absolute maximum ratings.

Specifications may change without notice.

Please download latest document from our official website www.dowaytech.com/en.

Recycling

The product(s) in this document need to be handed over to a qualified solid waste management services company for recycling in accordance with relevant regulations on waste classification after the end of the product(s) life.



No.2 Guangdong Road, Zhangjiagang Free Trade Zone, Jiangsu, China

Web: www.dowaytech.com/en E-mail: info@dowaytech.com

